



# ARCHIVES of FOUNDRY ENGINEERING

DOI: 10.1515/afe-2015-0093

ISSN (2299-2944)  
Volume 15  
Issue 4/2015

Published quarterly as the organ of the Foundry Commission of the Polish Academy of Sciences

134 – 140

## Mechanical Properties and Melt Quality Relationship of Sr-modified Al-12Si Alloy

M. Uludağ<sup>a\*</sup>, M. Uyaner<sup>a</sup>, F. Yılmaz<sup>b</sup>, D. Dişpinar<sup>c</sup><sup>a</sup> Selcuk University, Faculty of Engineering,

Metallurgical and Materials Eng. Dept., Konya-Turkey,

<sup>b</sup> Fatih Sultan Mehmet Vakıf University, Faculty of Engineering, Istanbul-Turkey,<sup>c</sup> Istanbul University, Faculty of Engineering, Metallurgical and Materials Eng. Dept., Istanbul-Turkey,

\*Corresponding author. E-mail address: uludag@selcuk.edu.tr

Received 24.04.2015; accepted in revised form 15.07.2015

### Abstract

The formation of oxide film on the surface of aluminium melts, i.e. bifilms, are known to be detrimental when they are incorporated into the cast part. These defects causes premature fractures under stress, or aid porosity formation. In this work, Al-12 Si alloy was used to cast a step mould under two conditions: as-received and degassed. In addition, 10 ppi filters were used in the mould in order to prevent bifilm intrusion into the cast part. Reduced pressure test samples were collected for bifilm index measurements. Samples were machined into standard bars for tensile testing. It was found that there was a good agreement with the bifilm index and mechanical properties.

**Keywords:** Aluminum-silicon alloys, Modification, Quality of casting, Bifilm index, Porosity

### 1. Introduction

Porosity has been the major factor that effect cast parts quality. Many of the existing quality control techniques involve checking the level, distribution and size of porosity in parts. In the foundry floors, typically, degassing method is used to reduce the dissolved hydrogen which has been blamed as the major source of porosity in aluminium castings. This process involves the purging of either argon or nitrogen through the melt where the excess hydrogen in the melt equilibrates with the rising bubbles and thus the level of hydrogen becomes decreased in the melt.

On the other hand, Campbell [1] proposed the idea of bifilms and it has been shown that hydrogen has a little effect on the porosity formation and bifilms acts as the major source for porosity in aluminium castings. Dişpinar [2-6] had shown that degassing process removes the bifilms in the melt and thus porosity decreases. In his study, Dişpinar [2] worked with two different melts and one of the melts were upgassed and the other one was

degassed in order to see the cross-effect of both hydrogen level and bifilm content. It was found that the melt with the lower hydrogen do not significantly had low porosity. It was the bifilm index that had direct relationship with the porosity and mechanical properties.

When it comes to the tensile properties of Al-Si alloys, Caceres [7-8] had done an extensive work. The effect of cooling rate (i.e. distance from chill) and modification by Sr were investigated and it was concluded that at small grain sizes the fracture was intergranular and at large grain size the fracture was transgranular. Strontium is added to Al-Si alloys to modify the elongated needle-like Si morphology to finer and fibrous shape. Zhongwei [9] showed that the addition of Sr decreases the eutectic temperature and reduces the dendrite coarsening thus decreases the dendrite size. Dahle [10] looked into the nucleation frequency of eutectic phase by Sr modification.

In this work, the fracture mechanism of Sr-modified Al-12Si alloy was investigated by means of bifilm theory. Two different

castings were made: turbulent and non-turbulent. Filters were used to collect bifilms. Reduced pressure test was used to quantify bifilm content.

### Experimental Work

The composition of the alloy is given in Table 1. As can be seen, the alloy already contained 460 ppm Sr, therefore no extra modification was carried out.

Table 1.

The spectral analysis of Sr modified Al-12Si alloy

Si	Fe	Mn	Mg	Ti	Na	Sr	P	V
11.35	0.13	0.008	0.16	0.097	0.0007	0.046	0.001	0.013

Resistance furnace was used to melt approximately 5.5 kg charge of the alloy at 675°C. Four melts were prepared under the same condition. For two of the melts, Ar was used as the purge gas and degassing was carried out by graphite lance for 12 minutes. In both of these castings, a filter was placed in the mould cavity as shown in Figure 1. This figure also shows the geometry of the cast part. As can be seen, a step mould with increasing thickness from bottom to the top (15, 25 and 40 mm) was used. The length of the part was 220 and the height of each section was 40 mm. Before each castings, reduced pressure test samples were

collected for bifilm index measurement. It is important to note that the non-degassed melts were poured into the mould cavity from approximately 35 cm height in order to generate turbulence. Samples were collected from each thickness and subjected to metallographical examination. In addition, standard tensile samples (Fig 2) were machined from the different thickness and tensile tests were performed. SEM analysis were also made on both the fracture surfaces by ZEISS LS-10.

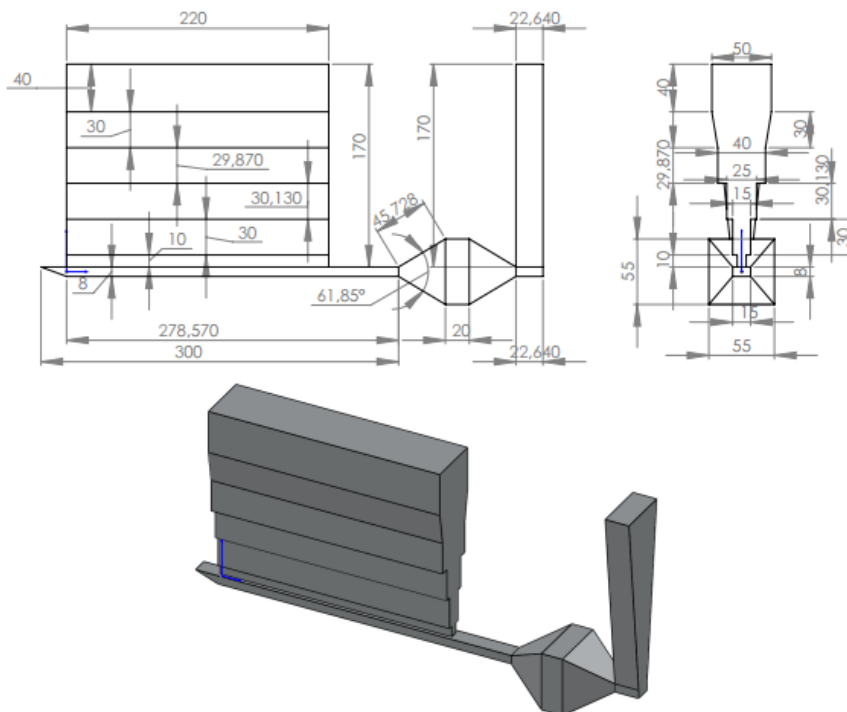

Fig. 1. The geometry of the cast part

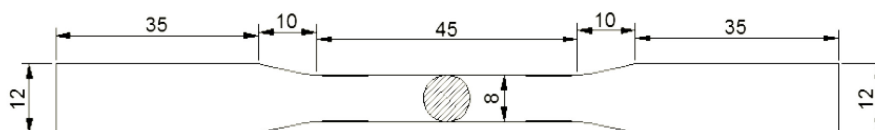

Fig. 2. The dimension of the tensile test bar

## 2. Results

Prior to cutting of tensile specimens from each casting, a small section was cut from the edge of the cast parts for macro and microstructural examination. The results are given in Figure 3 and Figure 4-5, respectively.

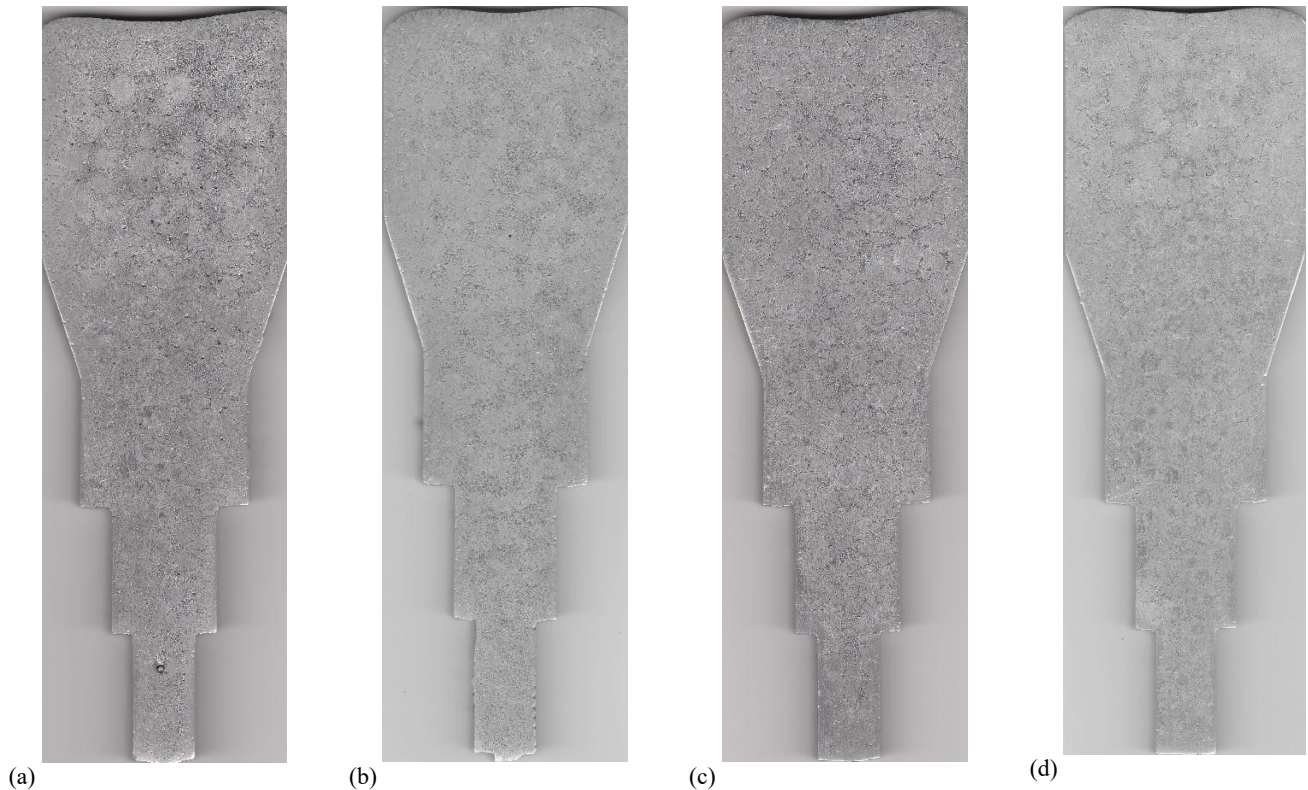

Fig. 3. Macro analysis of sectioned piece of cast parts  
 Untreated, turbulent filling (a) 1<sup>st</sup> casting, (b) 2<sup>nd</sup> casting  
 Degassed, controlled filling with filter (c) 1<sup>st</sup> casting, (d) 2<sup>nd</sup> casting

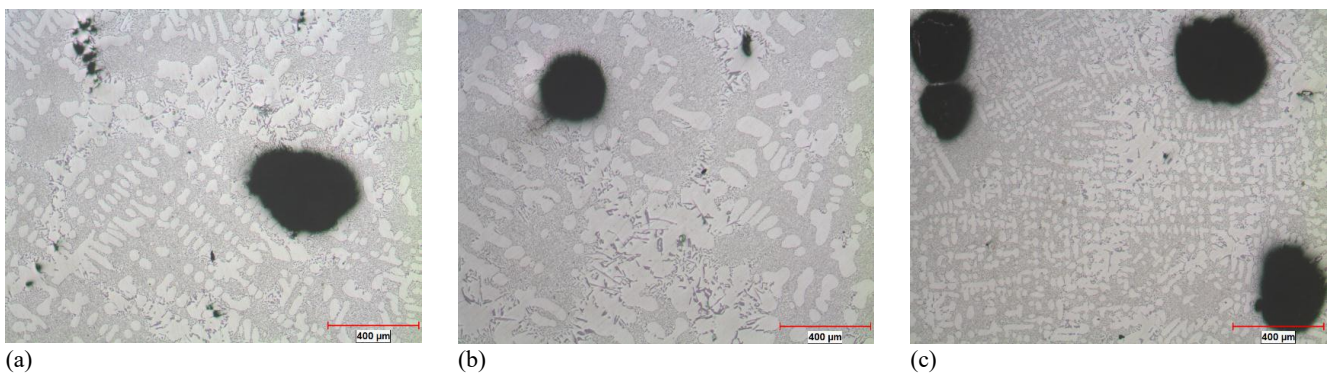

Fig. 4. Microstructures of each cross section (a) 15, (b) 20, and (c) 40 mm from the untreated turbulently filled castings

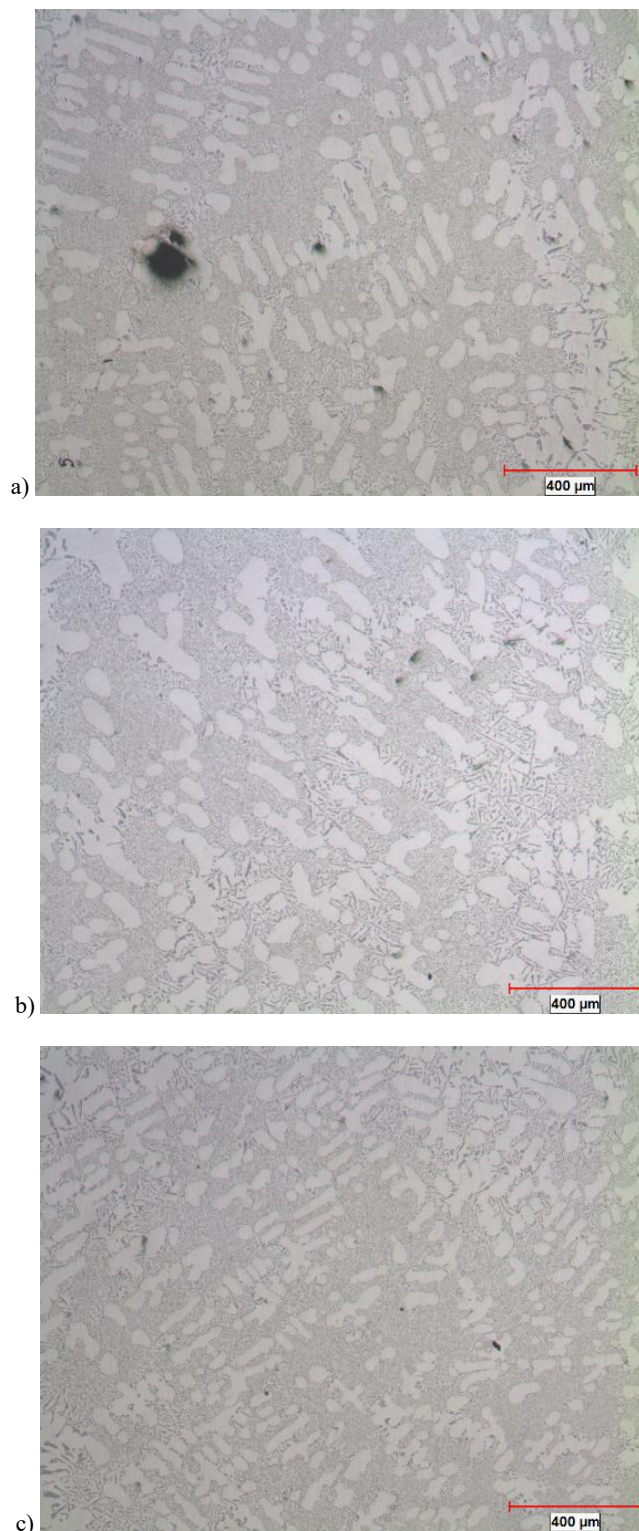

Fig. 5. Microstructures of each cross section (a) 15, (b) 20, and (c) 40 mm from the degassed controlled filling with filter

The porosity content of the castings was measured by Archimedes principle and the results are given with accordance to the section thickness in Figure 6.

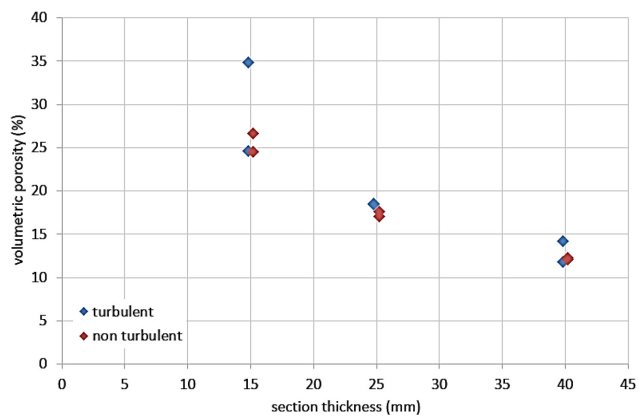

Fig. 6. Volumetric porosity change with section thickness for turbulent and non-turbulent fillings

The machined samples collected from each section thickness were subjected to tensile tests and ultimate tensile strength and elongation at fracture are given in Figures 7 and 8 respectively.

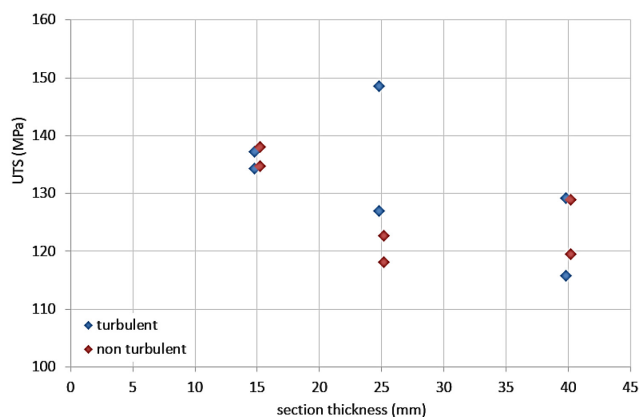

Fig. 7. Ultimate tensile stress change with section thickness

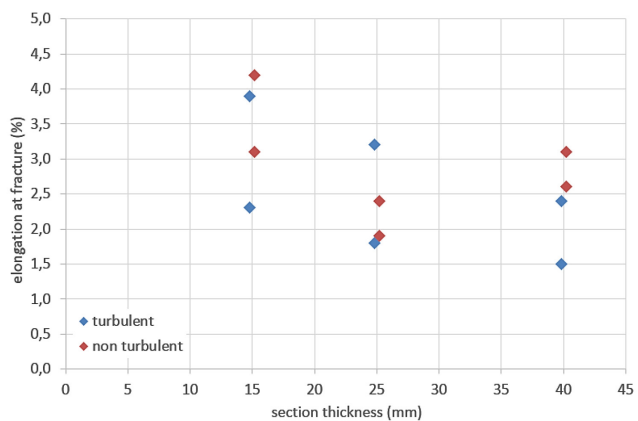

Fig. 8. Elongation at fracture change with section thickness

The relationship between the volumetric porosity and tensile test results are presented in Figures 9 and 10.

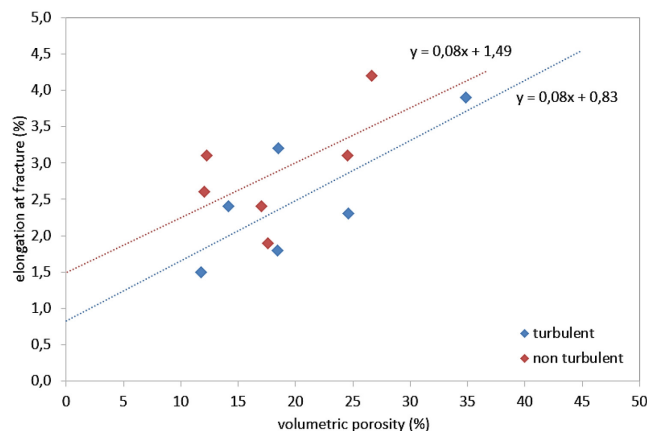

Fig. 9. Relationship between volumetric porosity and elongation at fracture

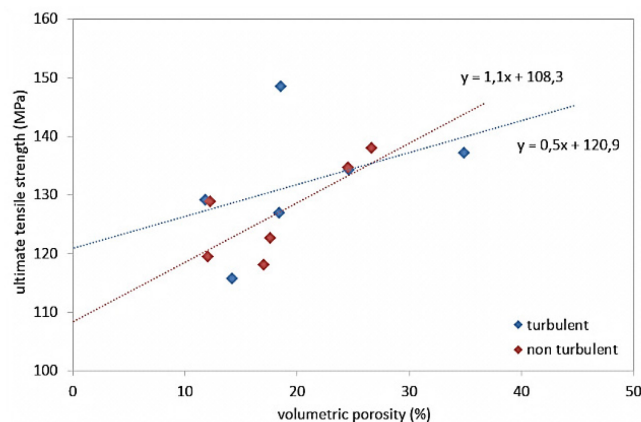

Fig. 10. Relationship between volumetric porosity and ultimate tensile stress

The melt quality measurement of the castings were carried by collection of RPT samples and calculation of the bifilm index. These results are given in Figure 11.

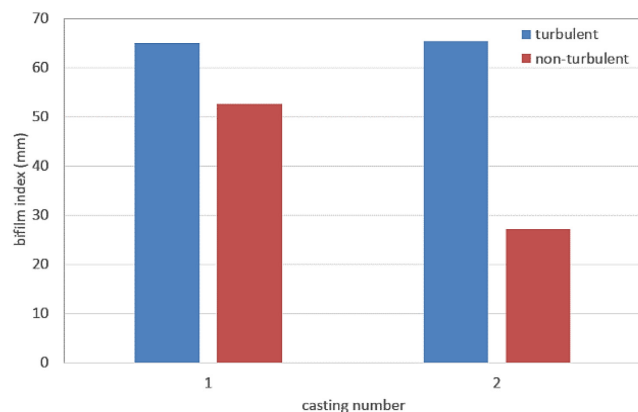

Fig. 11. Bifilm index results of all melts

SEM analysis were conducted on the fracture surface of the tensile test samples and the results are summarised in Table 2.

### 3. Discussion

After degassing and filter application during filling, only porosity levels were decreased in the cast parts. As seen in Figure 6, volumetric porosity values of the degassed is slightly lower than the untreated melt. These can be more clearly in Figure 3 where macro examination images were given. When Figure 4 and 5 is compared, it can be seen that the size of porosity is much higher in the turbulent fillings whereas there are still fine pores in the degassed and filtered castings. This is possibly due to the fact that the position of the filter in the runner bar was wrong. Hsu [13] had studied the various locations of the filter positioning. It was concluded that once the melt was passed through the filter, it should flow below the critical value to avoid turbulence [14]. Ardekhani [11] looked at the efficiency of filter for removing bifilms. Eissabadi [12] investigated the runner height after filtration. In this study, it was found that although filtering should increase quality, the position plays an important role. It can be concluded that the melt had passed through the filter and possibly sprayed to generate new and young bifilms. Therefore there was no direct distinguished difference between the filtered (non-turbulent) and un-filtered (turbulent) castings.

Looking at the tensile test results, in Figure 7 and 8, there is not much difference in UTS and elongation at fracture values of turbulent and non-turbulent fillings. Particularly, the elongation values were scattered all over the graph. The scatter in the turbulent fillings is due to the bifilms coming from the charge (since the melt was not degassed) and in addition, new bifilms were generated during filling. For the degassed melt, as mentioned in the previous paragraph, the scatter is due to the incorrect positioning of the filter.

When the relationship between the volumetric porosity and tensile results were plotted, a strange result was obtained as seen in Figures 9 and 10. It can be seen that as the volumetric porosity was increased, the UTS and elongation values had increased.

One of the interesting observations was that, when data were correlated with a linear line, the extrapolation of the line for the turbulent filling at zero porosity corresponds to 0.83 % elongation and for the non-turbulent filling, this value was found to be 1.49%. This indicated that regardless of the experimental findings in this work, yet, the non-turbulent filling with the usage of filter in the runner bar had a bit of improvement in the ductility (Table 2). It is important to note that the slopes of the linear lines from the equations in Figure 9 were 0.08 and same for both turbulent and non-turbulent fillings. On the other hand, in Figure 10, when the same interpretation was to be made, it can be seen that turbulent filling at zero volumetric porosity, the UTS value is 120,9 MPa for turbulent filling and 108,3 MPa for non-turbulent filling. Actually, similar results were found by Dispinar [2-6], and he had concluded that the intrusion of bifilms into the cast part had somehow acted as a metal matrix composite and strengthened the alloy to improve UTS but it was also observed, as it was found in this work, that the ductility was suffered in this case.

Table 2.  
SEM images taken from the fracture surface of tensile bars

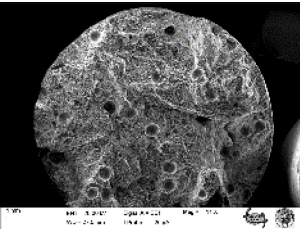
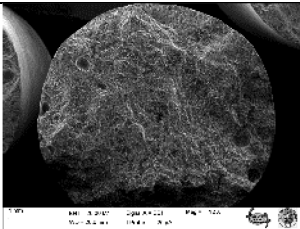
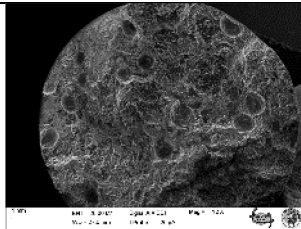
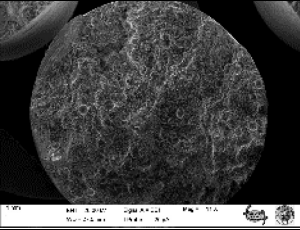
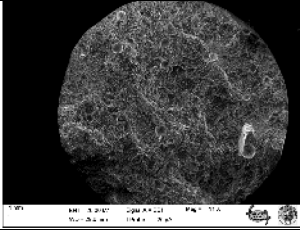
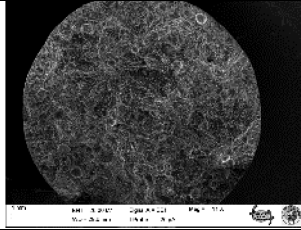
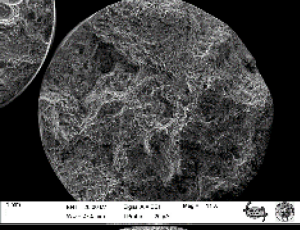
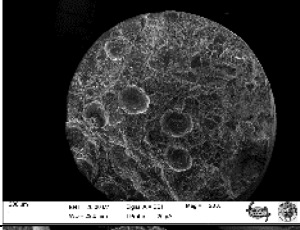
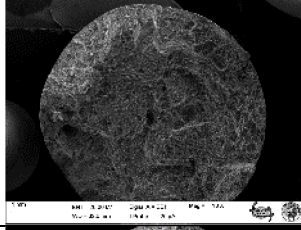
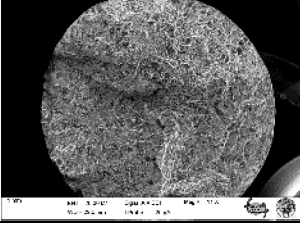
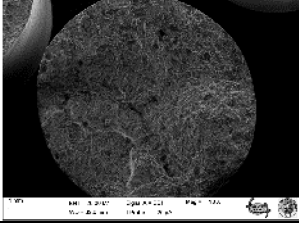
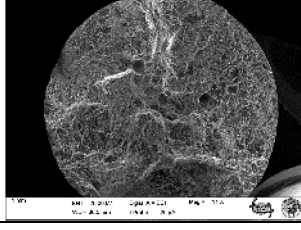
Section thickness:		15 mm	20 mm	40 mm
Casting Description:	Turbulent 1 <sup>st</sup> casting			
	Turbulent 2 <sup>nd</sup> casting			
	Non-turbulent 1 <sup>st</sup> casting			
	Non-turbulent 2 <sup>nd</sup> casting			

One interesting finding in this figure was the coinciding of the two linear lines at 27 % volumetric porosity with 135 MPa UTS value (Figure 10). For the porosity levels above this value, the effect of the bifilms may be more significant for the fracture mechanism of the turbulent filling. As can be seen, the UTS value for non-turbulent filling is increasing above the turbulent filling line.

For this eutectic alloy investigated in this work, it can be easily concluded that neither porosity, nor bifilms have significant effect over the fracture of the Sr modified Al-12Si alloys.

15 mm section thickness is the fastest cooling region in these trials due to the mould design. And the microstructural analysis show the finest structure with the utmost homogeneous microstructure. On the other hand, 40 mm section which is the thickest and theoretically slowest section, had the similar microstructure as 15 mm section. What was more interesting was the fact that thinnest section had the highest levels of porosity however they still had the highest mechanical properties.

## 4. Conclusion

1. In the Sr modified Al-12Si eutectic alloy, the effect of porosity on the mechanical properties seem to be efficient when the volumetric porosity is above 30 %.
2. Filter position in the runner bar plays a significant role in the generation or elimination of bifilms.
3. Thin sections solidifies rapidly to form larger pores compare to the thicker sections in eutectic Al-12Si alloy.
4. The finer the microstructure, the higher the tensile properties, regardless of the porosity levels in Sr-modified Al-12Si eutectic alloys.

## Acknowledgment

This work was supported by Scientific Research Projects Coordination Unit of Selçuk University. Project number 11101016. The casting experiments were carried out at Sakarya University, Technical Education Faculty. Microstructural analysis were performed at Altun Dokum A.S. (Konya, Turkey) and Hidromas Hidrolik Otomotiv ve Ticaret A.S. (Konya, Turkey).

## References

- [1] Campbell, J. (2011). *Complete Casting Handbook: Metal Casting Processes, Metallurgy, Techniques and Design*. 2011: Elsevier Butterworth-Heinemann.
- [2] Dispınar, D., et al., (2010). Degassing, hydrogen and porosity phenomena in A356. *Materials Science and Engineering a-Structural Materials Properties Microstructure and Processing*, 527 (16-17). 3719-3725.2.
- [3] Dispınar, D., et al., (2012). Tensile properties, porosity and melt quality relation of A356. Tms 2012 141st Annual Meeting & Exhibition - Supplemental Proceedings, Vol 2: Materials Properties, Characterization, and Modeling, 201-208.
- [4] Dispınar, D. & Campbell, J. (2004). Critical assessment of reduced pressure test. Part 1: Porosity phenomena. *International Journal of Cast Metals Research*, 17(5). 280-286.
- [5] Dispınar, D. & Campbell, J. (2006). Use of bifilm index as an assessment of liquid metal quality. *International Journal of Cast Metals Research*, 19(1). 5-17.
- [6] Dispınar, D. & Campbell, J. (2011). Porosity, hydrogen and bifilm content in Al alloy castings. *Materials Science and Engineering a-Structural Materials Properties Microstructure and Processing*. 528 (10-11). 3860-3865.
- [7] Cáceres, C.H., Davidson, C.J. & Griffiths, J.R. (1995). The deformation and fracture behaviour of an Al-Si-Mg casting alloy. *Materials Science and Engineering: A*, 197(2). 171-179.
- [8] Cáceres, C.H. & Griffiths, J.R. (1996). Damage by the cracking of silicon particles in an Al-7Si-0.4Mg casting alloy. *Acta Materialia*, 1996. 44(1). 25-33.
- [9] Zhongwei, C., Ruijie, Z. (2010). *Effect of strontium on primary dendrite and eutectic temperature of A357 aluminum alloy*. Research & Development.
- [10] Dahle, A.K., et al., (2005). Eutectic modification and microstructure development in Al-Si Alloys. *Materials Science and Engineering: A*. 413-414(0). 243-248.
- [11] Ardekhani, A. & Raiszadeh, R. (2012). Removal of Double Oxide Film Defects by Ceramic Foam Filters. *Journal of Materials Engineering and Performance*, 21(7). 1352-1362.
- [12] Eisaabadi Bozchaloei, G., et al. (2012). Effect of oxide bifilms on the mechanical properties of cast Al-7Si-0.3Mg alloy and the roll of runner height after filter on their formation. *Materials Science and Engineering: A*, 548(0). 99-105.
- [13] Fu Yuan Hsu et al., (2013). Ceramic Foam Filters in Runner System Design for Castings, *Key Engineering Materials*, 573, 19
- [14] Habibollah Zadeh, A., Campbell, J. (2013). Filter systems for high velocity liquid metal flow. *International Journal of Cast Metals Research*, 17(2), 99-106